



LED Technology

Unrivalled lifespan of up to 100,000 hours together with low power consumption and resistance to high levels of shock and vibration make LEDs the ideal light source for emergency lighting. Their compact size allows them to be used in a wide range of applications from surface mount flashing lamps to rotating beacons.



Magnetic Bases

Vision Alert magnetic based beacons are available in three speed ratings.

Maximum safe road speed is indicated in each relevant product table.

For beacons to mount successfully they must be attached to a clean, flat, dry, non porous, ferrous surface.



Lighting Symbols



Rotating LED
LED light source
with rotating
reflector.



LED



Rotating Halogen
Halogen bulb light
source with rotating
reflector.



Strobe
Xenon tube.



Beacons

Rotating LED	8
IONNIC 105 LED	10
IONNIC 101 LED	12
IONNIC 111 LED	13
Midi Vision	14
500 Series	16
Heavy Duty Xenon	18
Midi Xenon	20
Mini Vision	22
IONNIC Mini Xenon	23
Beacon Accessories	24

Beacons - LED

Rotating LED



108000

- True rotating LED.
- Heavy duty, virtually unbreakable.
- Patented 'Hybrid Drive' technology. No gears, no belts, no brushes.
- SAE Class 1 rated output.
- LEDs rated to 50,000 hours of operation.
- Low current draw.
- UV hard coated polycarbonate lens for high durability in harsh conditions.
- Magnetic version features 2600mm lead to cigar plug with integrated switch.
- Complies to over-dimensional vehicle regulations in several Australian states.
- 5 year warranty.

Voltage :	12-24V
Current Draw :	1.3A @ 12V
Wattage :	25.6W
Flash Rate :	120FPM
Lens :	Polycarbonate
Base :	Die-cast
Approvals :	ECE65, SAE J845 Class 1
Operating Temperature :	-30°C to 50°C
Light Source :	8 x 3W LED



Rotating LED Technology

Patented Hybrid Drive technology – no gears, no belts, no brushes to wear out.

Vision Alert Rotating LED products avoid problems typically found in gear or belt driven beacons by using a direct-drive stepper motor. A direct-drive stepper motor has much greater reliability than a brushed DC motor with either a gear or belt assembly, because the only moving parts are the shaft and rotor which are supported by two sealed bearings.

The stepper motor uses magnetic induction to rotate the rotor and shaft so there are no gears to slip or belts to break and no electrical brushes or other contacts to wear out.



Rotating Light Output.

The light emitted from the 8 LEDs is collimated into a beam that shines straight up from the base. A double sided mirror is mounted to the shaft of the direct-drive stepper motor at 45° to intercept the beam and is rotated in a 360° circle to sweep the beam much like a standard halogen rotator.



Extended life of LEDs over alternative lighting.

By default LEDs provide a longer working life and greater resistance to vibration over alternative forms of lighting. Additionally LEDs do not require the use of a costly and life limiting flash capacitor as required in flashing xenon beacons.

Lower current draw from LEDs.

LEDs require less current draw to provide an equal or greater light output compared to alternative lighting technologies.

- Rotating LED Beacon – 1.3A @ 12V
- Heavy Duty Xenon Beacon – 2.3A @ 12V
- Rotating Halogen Beacon – 4.6A @ 12V

Beacons - LED



Rotating LED - 3 Bolt

12-24V Amber **107000** Blue **107200** Green **107300** Red **107400**

Supplied with 3 x M5 Bolts.
Mounting: 3 x Ø 5mm holes @ 151 PCD.
300mm free length of cable.
Blue model is shipped with a clear lens.

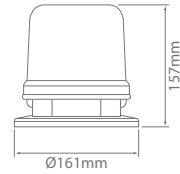

Rotating LED - Pole Mount

12-24V Amber **107002**

Other colours available upon request, lead times apply.

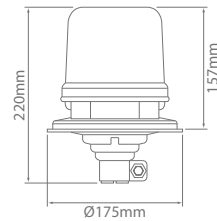

Rotating LED - Mag 60

12-24V Amber **108000** Blue **108200** Green **108300** Red **108400**

2.6m lead to cigar plug with integrated switch.
Blue, green and red models are a non stocked item, lead times apply.

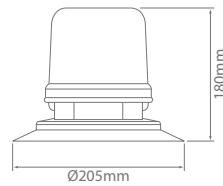

Beacons - LED

IONNIC 105 LED

105000



- Ultra high intensity LEDs - exceeds SAE class 1 rated output *.
- 24 flash patterns including 2 simulated rotating.
- Heavy duty construction for increased durability.
- Epoxy filled electronics for enhanced moisture & vibration protection.
- Low current draw.
- Multi-voltage.
- 3 Bolt versions can be synchronised.
- Magnetic version features cigar plug with integrated on/off & pattern select switches.
- High/low intensity, 3 Bolt version only.
- 5 year warranty.

Voltage : 12-24V
Current Draw : 0.6A @ 12V
Flash Patterns : 24
Simulated Rotating Flash Rate : 78/162FPM
Lens : Polycarbonate
Base : Die-cast
Approvals : *excludes green SAE J845 Class 1
Operating Temperature : -50°C to 55°C
Light Source : 8 x High Output LEDs

12V
24V

5Yrs



Epoxy filled electronics



On/off and pattern select



Exceeds Class 1 Rated Light Output

The IONNIC 105 LED beacon range, features a unique 'balloon' lens that spreads and amplifies the light, producing in excess of Class 1 rated output from only 8 high output LEDs.





4 pairs of high output LEDs.

Beacons - LED

NEW IONNIC 105 LED - 3 Bolt

12-24V **Amber** 105000 **Blue** 105200 **Green** 105300 **Red** 105400 **White** 105500

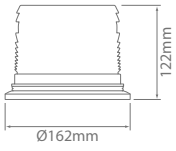

Supplied with 3 x M5 bolts, nuts & shake-proof washers.
 Mounting: 3 x Ø 5mm holes @ 150mm PCD.
 470mm free length of cable.

NEW IONNIC 105 LED - Pole Mount

12-24V **Amber** 105002

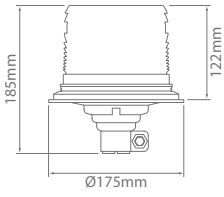

Other colours available upon request.
 Preset to rotate light pattern.

NEW IONNIC 105 LED - Magnetic

12-24V **Amber** 105010 **Blue** 105210 **Green** 105310 **Red** 105410 **White** 105510

3.4m lead to cigar plug with integrated switch.

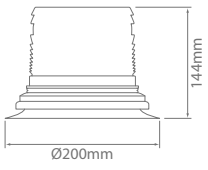
105 Series Lens

Part No.	Colour
910011	Amber
910022	Blue
910033	Green
910044	Red
910055	Clear



Beacons - LED

IONNIC 101 LED



- SAE class 1 rated output.
- Aerodynamic low profile.
- 5 flash patterns available - 2 simulated rotating (120FPM).
- Polycarbonate lens for high durability.
- Epoxy filled base for enhanced moisture & vibration protection.
- Low current draw.
- Multi-voltage.
- Environmentally sealed - IP67.
- Dimming function.
- Complies to over-dimensional vehicle regulations in several Australian states.
- 5 year warranty.

Voltage :	12-36V
Current Draw :	2.8A @ 12V
Wattage :	33W
Flash Patterns :	5
Lens :	Polycarbonate
Base :	Aluminium
Wire Length :	340mm
Approvals :	ECE R65, SAE J845 Class 1
Ingress Protection :	IP67
Operating Temperature :	-30°C to 50°C
Light Source :	12 x 3W LED

12V 36V IP67 5Yrs

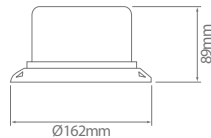

NEW

IONNIC 101 LED - 3 Bolt

Amber
101000

12-36V

Supplied with 3 x M6 bolts, nuts, shake-proof washers & base gasket.
Mounting: 3 x Ø 7mm holes @ 151mm PCD.

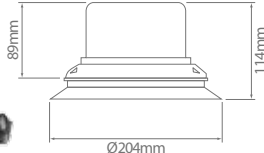

NEW

IONNIC 101 LED - Magnetic

Amber
101010

12-36V

4.6m lead to cigar plug with integrated switch.

- 6 flash patterns available.
- Low profile design.
- Polycarbonate lens provides high durability against harsh conditions.
- Silicon filled base for enhanced moisture & vibration protection.
- Ideal for forklift & other industrial applications.
- Low current draw.
- Multi-voltage.



Voltage : 12-48V
Current Draw : 0.2A @ 12V
Flash Rate : 68FPM (all patterns)
Flash Patterns : 6
Lens : Polycarbonate
Base : ABS
Wire Length : 300mm
Operating Temperature : -30°C to 50°C
Light Source : 4 x 1W LED

12V
24V



NEW

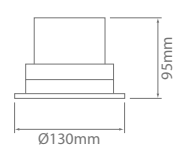

NEW
IONNIC 111 LED - 3 Bolt
Amber
111000
 12-48V

Supplied with 3 x M5 bolts, nuts, shake-proof washers & base gasket.
 Mounting: 3 x Ø 5mm holes @ 118 PCD.

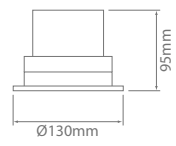

NEW
IONNIC 111 LED - Magnetic
Amber
111010
 12-48V

3.0m lead to cigar plug with integrated switch.



Beacons - Halogen

Midi Vision

400001



- Aerodynamic low profile.
- Free-form reflector provides 20% more light output over previous models.
- Whisper quiet rotators, running on stainless steel/acetal bearings.
- Polycarbonate lens provides high durability against harsh conditions.
- Multiple mounting configurations.
- Twist lock polycarbonate lens provides easy field maintenance.
- Magnetic models feature 2600mm retractable coil with cigar plug.
- Dual voltage motor.

Current Draw :	4.6A @ 12V	3A @ 24V
Max. Wattage :	55W @ 12V	70W @ 24V
Flash Rate :	160FPM	
Lens :	Polycarbonate	
Base :	ABS	
Light Source :	H1 Halogen Bulb	



Free-form optics generate greater & more focused light output



Twist lock lens provides easy field maintenance

Mag70
MAX
112
KM/H

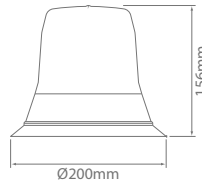

400 Series - Mag 70

	Amber	Din. Blue	Cal. Blue	Green	Red
Less Bulb	400000	400100	400200	400300	400400
12V	400001	400101	400201	400301	400401
24V	400002	400102	400202	400302	400402

Cord extends to 2.6m length, plug fits standard cigar/DIN socket.

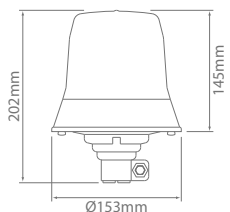

402 Series - Pole Mount

	Amber	Din. Blue	Cal. Blue	Green	Red
Less Bulb	402000	402100	402200	402300	402400
12V	402001	402101	402201	402301	402401
24V	402002	402102	402202	402302	402402

Single pole plug to DIN 72591.

Beacons - Halogen



403 Series - 3 Bolt

	Amber	Din. Blue	Cal. Blue	Green	Red
Less Bulb	403000	403100	403200	403300	403400
12V	403001	403101	403201	403301	403401
24V	403002	403102	403202	403302	403402

Supplied with 3 x M6 bolts, nuts, shake-proof washers.
Mounting: 3 x Ø 7mm holes @ 130 PCD.
300mm free length of cable.

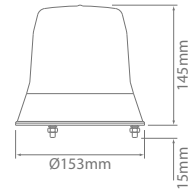

404 Series - Flexi

	Amber	Din. Blue	Cal. Blue	Green	Red
Less Bulb	404000	404100	404200	404300	404400
12V	404001	404101	404201	404301	404401
24V	404002	404102	404202	404302	404402

Flexible single pole plug to DIN 72591.

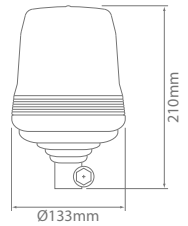

407 Series - Mag 50

	Amber	Din. Blue	Cal. Blue	Green	Red
Less Bulb	407000	407100	407200	407300	407400
12V	407001	407101	407201	407301	407401
24V	407002	407102	407202	407302	407402

Cord extends to 2.6m length, plug fits standard cigar/DIN socket.

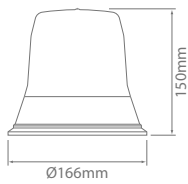

403 Series - 240 Volt

	Amber	Din. Blue	Cal. Blue	Green	Red
240V	403000-240V	403100-240V	403200-240V	403300-240V	403400-240V

Must be installed by a qualified 240 volt electrician.
Cable gland clamping range - Ø 3.5mm.

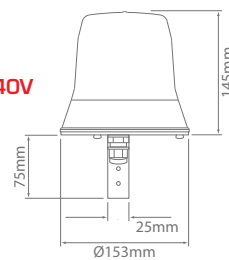

Midi Lens

Part No.	Colour
910320	Amber
910321	Din. Blue
910322	Cal. Blue
910325	Green
910324	Red



Midi Vision Spares

Part No.	Description
999554	Rotator Module
910336	Reflector only
910030	Beacon Base
945034	Drive Belt - Flat
920004	Bulb - Clip
64150	H1 Bulb - 12V, 55W
64155	H1 Bulb - 24V, 70W



Beacons - Halogen

500 Series



503001

- Free-form reflector provides 20% more light output over previous models.
- Whisper quiet rotators, running on stainless steel/acetal bearings.
- Multiple mounting configurations.
- Twist lock acrylic lens provides easy field maintenance.
- Magnetic models feature 2600mm retractable coil with cigar plug.
- Dual voltage motor.

Current Draw : 4.6A @ 12V 3A @ 24V
 Max. Wattage : 55W @ 12V 70W @ 24V
 Flash Rate : 160FPM
 Lens : Acrylic
 Base : ABS
 Light Source : H1 Halogen Bulb



Free-form optics generate greater & more focused light output



Twist lock lens provides easy field maintenance

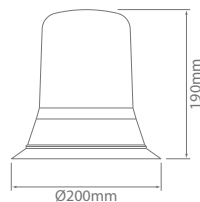

500 Series - Mag 70

	Amber	Din. Blue	Cal. Blue	Green	Red
Less Bulb	500000	500100	500600	500400	500500
12V	500001	500101	500601	500401	500501
24V	500002	500102	500602	500402	500502

Cord extends to 2.6m length, plug fits standard cigar/DIN socket.

Beacons - Halogen



503 Series - 3 Bolt

	Amber	Din. Blue	Cal. Blue	Green	Red
Less Bulb	503000	503100	503600	503400	503500
12V	503001	503101	503601	503401	503501
24V	503002	503102	503602	503402	503502

Supplied with 3 x M6 bolts, nuts, shake-proof washers.
Mounting: 3 x Ø 7mm holes @ 130 PCD.
300mm free length of cable.

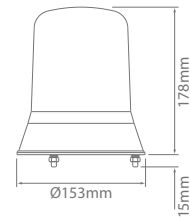

507 Series - Mag 50

	Amber	Din. Blue	Cal. Blue	Green	Red
Less Bulb	507000	507100	507600	507400	507500
12V	507001	507101	507601	507401	507501
24V	507002	507102	507602	507402	507502

Cord extends to 2.6m length, plug fits standard cigar/DIN socket.

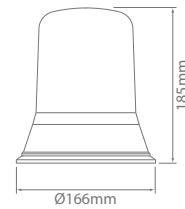

500 Series Lens

Part No.	Colour
910023	Amber
910024	Din. Blue
910028	Cal. Blue
910155	Green
910153	Red
910150	Magenta



500 Series Spares

Part No.	Description
999555	Rotator Module
910352	Reflector only
910030	Beacon Base
945034	Drive Belt - Flat
920004	Bulb - Clip
64150	H1 Bulb - 12V, 55W
64155	H1 Bulb - 24V, 70W



Free-Form Optics

All Vision Alert beacon & lightbar ranges incorporate Free-form optical technology.

This advancement in reflector design produces a more powerful and larger square beam increasing light output by 20% over previous designs.

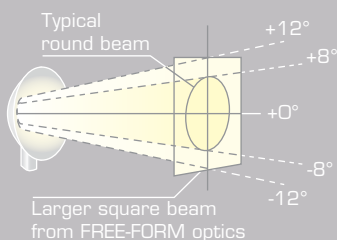

Dual Voltage

All Vision Alert halogen beacon & lightbar ranges use our proven dual voltage belt drive incorporating an updated version of our market leading, whisper-quiet rotators.

By changing the drive belt to the desired pulley and fitting the required voltage H1 bulb, any Vision Alert beacon or lightbar can be configured to suit 12V or 24V.

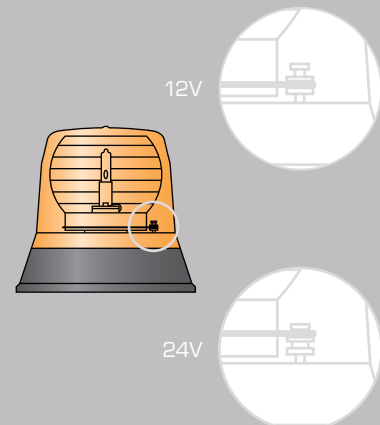

Beacons - Xenon

Heavy Duty Xenon



100363

- Corrosion resistant coated die-cast or nylon base.
- Selectable Dual or Quad Flash.
- Energy saving xenon technology.
- Epoxy filled base for enhanced moisture and vibration protection.
- Die-Cast Base model features "I-Beam" fault diagnostics LED.
- Multi-voltage.
- 2 year warranty.

2Yrs 12V 24V

Voltage :		12-24V
Flash Rate :		80/65FPM
Current Draw :	Die-Cast Base	Nylon Base
	2.3A @ 12V	1.5A @ 12V
Double Flash Output :	10 Joules	7 Joules
Quad Flash Output :	16 Joules	10 Joules
Lens :		Polycarbonate
Wire Length :		300mm
Approvals :		SAE J845 Class 2
Light Source :		1 x Xenon Tube

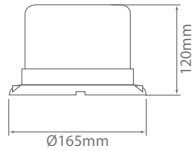

Heavy Duty Xenon - Die-Cast Base

	Amber	Blue	Green	Red
12-24V	100263	100281	100269	100275

Supplied with 3 x M5 bolts, nuts, shake-proof washers.
Mounting: 3 x Ø 5mm holes @ 151mm PCD.

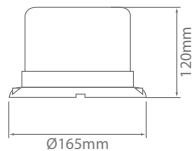

Heavy Duty Xenon - Nylon Base

	Amber	Blue	Green	Red
12-24V	100363	100381	100369	100375

Supplied with 3 x M5 bolts, nuts, shake-proof washers.
Mounting: 3 x Ø 5mm holes @ 151mm PCD.

Beacons - Xenon

Heavy Duty Lens

Part No.	Colour
910391	Amber
910392	Blue
910393	Green
910394	Red
910395	Clear



Heavy Duty Xenon Spares

Part No.	Description
960055	Xenon Tube



Shown attached to an IONNIC 101 LED



Vacuum Magnetic Mount Kit

Part No.	Description
A600VMK	Vacuum magnetic base and 4.6m lead to cigar plug with integrated on/off switch

Suitable for use with Rotating LED, IONNIC 101 LED and Heavy Duty Xenon beacons.



Beacons - Xenon

Midi Xenon



5802DO

- Energy saving xenon technology.
- Long life replaceable tubes.
- Multiple mounting configurations.
- Twist lock polycarbonate lens provides easy field maintenance.
- Multi-voltage.

10V
48V

Voltage :	10-48V
Current Draw :	1.4A @ 12V
Flash Rate :	Double 75FPM
	Quad 70FPM
Output :	Double Flash 6 Joules
	Quad Flash 8 Joules
Lens :	Polycarbonate
Base :	ABS
Light Source :	1 x Xenon Tube

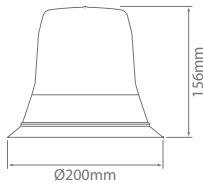

580 Series - Mag 70

Double Flash
10-48V

Amber
5802DO

Din. Blue
5803DO

Cal. Blue
580CDO

Green
5807DO

Red
5808DO

Cord extends to 2.6m length, plug fits standard cigar/DIN socket.

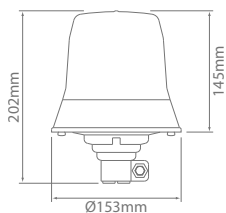

582 Series - Pole Mount

Double Flash
10-48V

Amber
5822DO

Din. Blue
5823DO

Cal. Blue
582CDO

Green
5827DO

Red
5828DO

Single pole plug to DIN 72591.

Beacons - Xenon



583 / 593 Series - 3 Bolt

	Amber	Din. Blue	Cal. Blue	Green	Red
Double Flash 10-48V	5832DO	5833DO	583CDO	5837DO	5838DO
Quad Flash 10-48V	5932QO	5933QO	593CQO	5937QO	5938QO

Supplied with 3 x M6 bolts, nuts, shake-proof washers.
Mounting: 3 x Ø 7mm holes @ 130mm PCD.
300mm free length of cable.

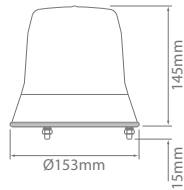

584 Series - Flexi

	Amber	Din. Blue	Cal. Blue	Green	Red
Double Flash 10-48V	5842DO	5843DO	584CDO	5847DO	5848DO

Flexible single pole plug to DIN 72591.

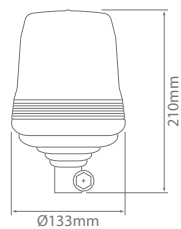

Midi Xenon Lens

Part No.	Colour
910136	Amber
910285	Din. Blue
910135	Cal. Blue
910134	Green
910133	Red
910139	Clear



Midi Xenon Spares

Part No.	Description
999223	Xenon Tube
910030	Beacon Base



Beacons - Xenon

Mini Vision



10V
80V

- Energy saving xenon technology.
- Polycarbonate lens provides high durability against harsh conditions.
- Compact size, ideal for forklift and other industrial applications.
- Low current draw.
- Multi-voltage.

Voltage : 10-80V
 Current Draw : 0.4A @ 12V
 Flash Rate : 80FPM
 Output : 1.5 Joules
 Lens : Polycarbonate
 Base : ABS
 Wire Length : 300mm
 Light Source : 1 x Xenon Tube

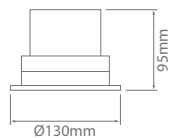

563 Series - 3 Bolt

Single Flash
10-80V

Amber
563208

Blue
563C08

Green
563708

Red
563808

Mounting: 3 x Ø 5mm holes @ 118 PCD.

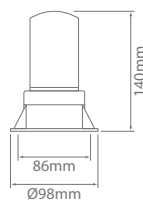

566 Series - 2 Bolt

Single Flash
10-80V

Amber
566288

Blue
566C88

Green
566788

Red
566888

Mounting: 2 x Ø 5mm holes.

Mini Vision Lens

563 Series	566 Series	Colour
910065	910085	Amber
910066	910086	Blue
910067	910087	Green
910068	910088	Red
910069	910089	Clear



Xenon Tubes

Part No.	Description
960085	563 Series
960012	566 Series



Beacons - Xenon

IONNIC Mini Xenon

- Value range of xenon beacons.
- Ideal for forklift applications.
- Offered in high or low profiles.
- High profile model features epoxy filled base.
- Multi-voltage.

Voltage :	12-80V
Current Draw :	0.29A @ 12V
Flash Rate :	6400A-1 36FPM
	6220A-2 72FPM
Output :	2 Joules
Lens :	Polycarbonate
Base :	ABS
Wire Length :	300mm
Light Source :	1 x Xenon Tube



12V
80V

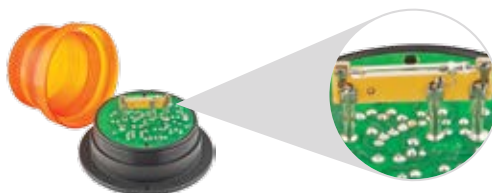

IONNIC Mini Xenon - 3 Bolt

Single Flash
12-80V

Amber
6400A-1

Supplied with 3 x M5 bolts, nuts, shake-proof washers.
Mounting: 3 x Ø 5mm holes @ 118 PCD.

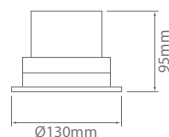

IONNIC Mini Xenon - 2 Bolt

Single Flash
12-80V

Amber
6220A-2

Supplied with 2 x M5 bolts, nuts, shake-proof washers.
Mounting: 2 x Ø 5mm holes.

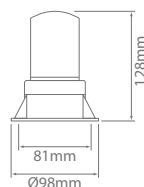

Beacon Accessories



DIN/Cigar Sockets

Part No.	Type	Current Rating	Voltage	Cap Style	Terminal Style	Housing	Mounting Diameter (mm)
53114320	DIN	12A	—	Spring Loaded	Parallel	Brass	18
57607000	DIN	12A	—	—	Parallel	Brass	18
57607002	DIN	12A	—	Press Fit	Parallel	Brass	18
57907111	DIN	12A	—	Spring Loaded	Offset	Brass	18
53114321	DIN	12A	—	—	Screw	Aluminium	—
57612002	DIN	16A total	—	—	Parallel	Thermoplastic	—
57620000	DIN	16A	—	—	Parallel	Thermoplastic	—
57906030	Cigar	15A	—	Press Fit	Offset	Stainless Steel	27.5
68031170	Cigar	—	12	—	Offset	Stainless Steel	28
68040800	Cigar	20A	—	Press Fit	Offset	Stainless Steel	27.5

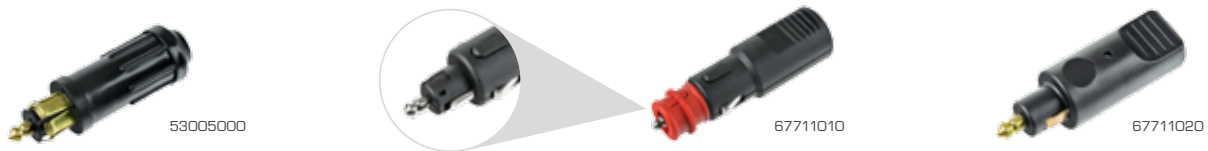

DIN/Cigar Plugs

Part No.	Current Rating	Style	Housing	Notes
53005000	12A	DIN	Thermoplastic	—
67711010	12A	Cigar/DIN	Thermoplastic	Incorporates strain relief
67711020	8A	DIN	Thermoplastic	—



Adaptors & Extension Cables

Part No.	Description	Current Rating	Cable (cm)	Housing
56609000	Cigar/DIN plug to cigar socket. 6-24V	2 x 5A	20	Thermoplastic
56630000	DIN plug to cigar socket	12A	—	Thermoplastic
67874000	Battery terminal clips to cigar socket	8A	95	Thermoplastic
67814000	Cigar/DIN plug to DIN socket	8A	385	Thermoplastic
67818100	Cigar/DIN plug to cigar socket	8A	60 - 300	Thermoplastic

Beacon Accessories



Mounting Plates for 3 Bolt Beacons

Part No.	Mounting	Suits	PCD (mm)
905001	90°	Midi Vision, 500 Series, Midi Xenon	130
905002	90°	Midi Vision, 500 Series, Midi Xenon	130
905005	Flat surface	Midi Vision, 500 Series, Midi Xenon	130
905003	Large flat	LED Rotating, IOINNIC 105, IOINNIC 101, Heavy Duty Xenon	151
905009	Large 90°	LED Rotating, IOINNIC 105, IOINNIC 101, Heavy Duty Xenon	151



Protective Grilles

Part No.	Description	Maximum Height (mm)
GRL	Standard Duty	145
GR	Standard Duty	195
GRL-HD NEW	Heavy duty - 5mm cage	145
GR-HD NEW	Heavy duty - 5mm cage	195



Brackets & Extensions

Part No.	Description	Mount Style
100056	Pole mount with integral DIN socket	Bolt down - 2 bolt
100057	Pole mount with integral DIN socket	Weld
100058	Pole mount with integral DIN socket	Threaded
100059	Pole mount with integral DIN socket	Side mount - 2 bolt
100074	Fold-down pole mount with integral DIN socket	Bolt down - 2 bolt
100161	Pole mount extension - 490mm. Supplied with mounting hardware. Requires 100057	
100162	Adjustable pole mount extension - 740mm to 1300mm. Supplied with mounting hardware. Requires 100057	

